

PIPE ROLLERS

SIZE RANGE: 90 - 1000 MM

FIXED HEIGHT & ADJUSTABLE HEIGHT



Ultimate Solutions.
Intelligent Delivery.



UPG supplies a range of pipe rollers to support and guide PE pipe when butt-welding. All units are made from quality steel with durable roller assemblies and heavy duty shafts. All components are galvanised to ensure long life out on site in all conditions.

There are three variations available:

- Pipe Roller 400 – Suited for 90-400mm Pipe
- Pipe Roller 560 – Suited for 90-560mm Pipe
- Pipe Roller 1000 – Suited for 125-1000mm Pipe

Customised options available on request.

400MM FIXED HEIGHT PIPE ROLLER



COMMENTS

Can support pipes up to 400mm. Easy to use and light enough to move around on-site. Has holes on frame for fixing to ground or timber supports.

TECHNICAL FEATURES

MODEL	400MM FIXED HEIGHT PIPE ROLLER
Code	9950-UPR400G
Working Range	63mm-400mm
Max Dimensions	360 x 220 x 200 mm
Weight	8 kg

WELLINGTON

17 Raiha Street, Porirua

AUCKLAND

3/68 McLaughlins Road, Wiri

P 0800 473 100

E sales@upg.net.nz

W upg.nz

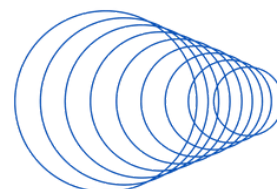

560MM FIXED HEIGHT PIPE ROLLER



COMMENTS

Can support pipes up to 560mm. Easy to use and light enough to move around on-site. Has holes on frame for fixing to ground or timber supports.

TECHNICAL FEATURES

MODEL	560MM FIXED HEIGHT PIPE ROLLER
Code	9950-UPR560G
Working Range	90mm-560mm
Max Dimensions	360 x 220 x 200 mm
Weight	9 kg

WELLINGTON

17 Raiha Street, Porirua

AUCKLAND

3/68 McLaughlins Road, Wiri

P 0800 473 100

E sales@upg.net.nz

W upg.nz

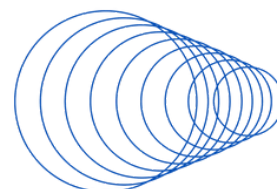

1000MM FIXED HEIGHT PIPE ROLLER



COMMENTS

Can support pipes from up to 1000 mm. The structure is heavy duty and rollers are galvanized for long-life. Working range from 315 to 1000 mm. Has holes on frame for fixing to ground or timber supports.

TECHNICAL FEATURES

MODEL	1000MM FIXED HEIGHT PIPE ROLLER
Code	9950-UPR1000G
Working Range	315mm-1000mm
Max Dimensions	1040 x 600 x 320 mm
Weight	27 kg

WELLINGTON

17 Raiha Street, Porirua

AUCKLAND

3/68 McLaughlins Road, Wiri

P 0800 473 100

E sales@upg.net.nz

W upg.nz

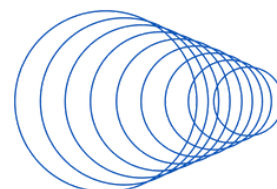

ADJUSTABLE HEIGHT PIPE ROLLERS



COMMENTS

Adjustable pipe rollers allow for variations in ground heights or welder set-ups.

A simple design utilising sliding box section and pins to set the stand height. These rollers will accommodate pipe from 180mm up to 1000mm. Each roller has 200mm of vertical height adjustment from the minimum height.

UAPR-1000G-400 – Adjustable Height Roller to suit pipe 180-1000mm (400mm min height)

UAPR-1000G-650 – Adjustable Height Roller to suit pipe 180-1000mm (650mm min height)

UAPR-1000G-900 – Adjustable Height Roller to suit pipe 180-1000mm (900mm min height)

Other variations available on request.

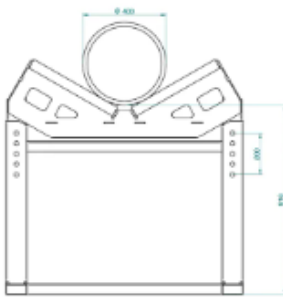

UAPR-1000G-900 Full Assembly

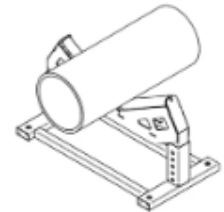
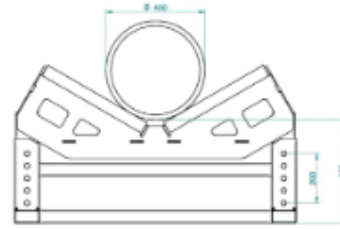

UAPR-1000G-400 Full Assembly

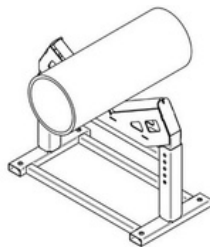
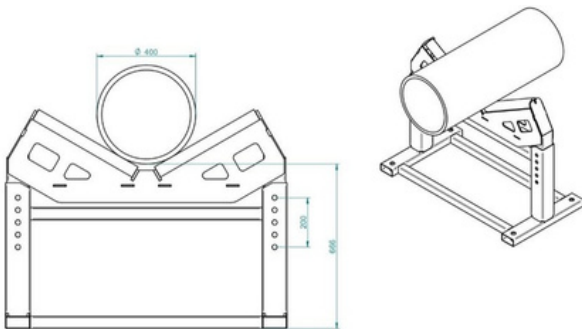

UAPR-1000G-650 Full Assembly

WELLINGTON

17 Raiha Street, Porirua

AUCKLAND

3/68 McLaughlins Road, Wiri

P 0800 473 100

E sales@upg.net.nz

W upg.nz

